

ML09750 SAFETY INFORMATION

ML09750 Laser Line Projector - **GreenLine** 1MM SAFETY INFORMATION

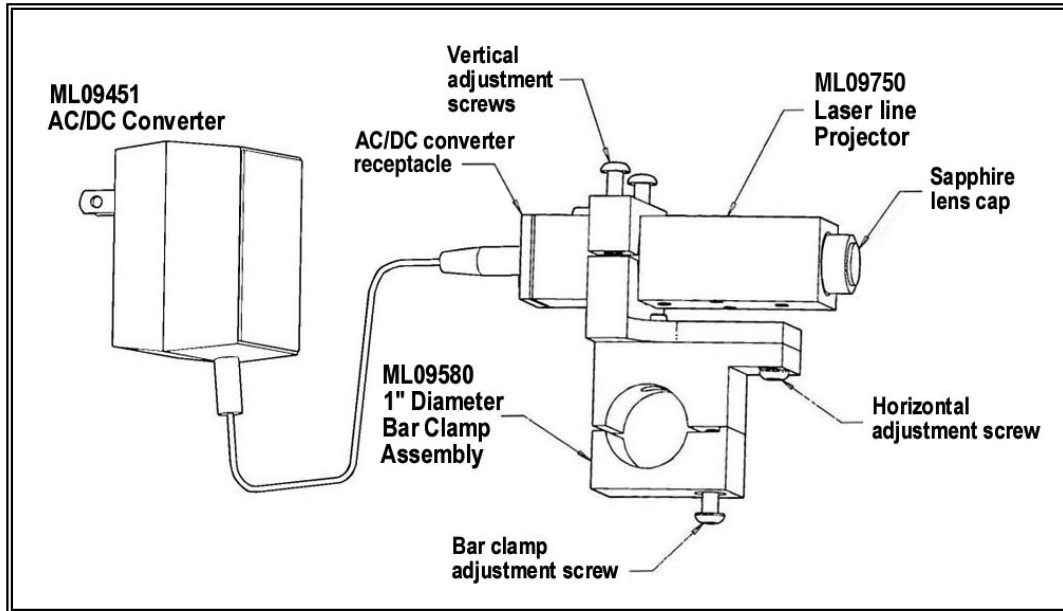

The Everhard ML09750 laser line projector is a Class II laser product. This laser product has a maximum power of 1 milliwatt or less. The unit is considered "eye safe" under normal operating conditions.

FOLLOW THE NECESSARY PRECAUTIONS:

- DO NOT STARE INTO LASER BEAM.
- LASER LIGHT CAN BE DAMAGING TO THE EYES. DO NOT LOOK INTO THE APERTURE WHEN THE LASER IS IN OPERATION.

CAUTION: Use of controls or adjustments or performance of procedures other than those specified herein may result in hazardous laser radiation exposure. Everhard Products, Inc., or any of its subsidiaries, will not accept any liability for any damage or injury caused by the incorrect use of this product.

LABELING INFORMATION

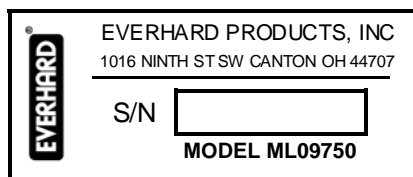

90-608

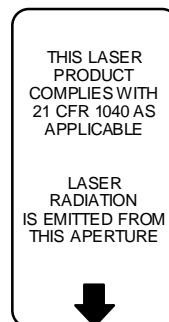

90-505

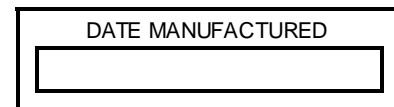

90-520

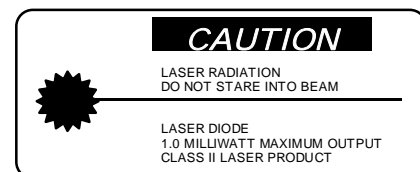

90-504

IMPORTANT NOTE: Install and operate the projector only with Everhard model #ML09451 120VAC / 7.5VDC 1.0A 7.5W regulated AC/DC converter or equivalent.

WARNING: Failure to install and operate the projector with the ML09451 AC/DC converter or equivalent will void the warranty for the projector.